



# DECODOOR





DECODOOR, which has been serving in the door sector since 1990, reflects its experience to its quality products. Our qualified staff, who adhere to modern conditions and give priority to customer priority, produce solid and healthy living spaces in your homes and businesses.

DECODOOR fulfills its responsibilities with 30 years of experience. We share with you the rightful pride of being in the top of the sector with our quality service and our ever-evolving service policy, with our qualified staff who meet the requirements of the ages and with our quality raw materials we use in our products with the best quality and best price. You can change the look of your houses, your workplaces ...

It would be enough for you to come to the DECODOOR.

تعكس شركة ديكودور، التي تعمل في قطاع الأبواب منذ عام ١٩٩٠، خبرتها في منتجاتها ذات الجودة العالية. إن موظفينا المؤهلين، الملتزمين بالتكنولوجيا الحديثة ويعطون الأولوية لراحة العملاء، يساعدونكم في إنشاء مساحات معيشة قوية وصحية في منازلكم وشركتكم. تفي شركة ديكودور بمسؤولياتها بخبرة أكثر من ثلاثين سنة.

نحن نشارككم الفخر المستحق لكوننا في صدارة القطاع من خلال خدماتنا عالية الجودة وسياسة الخدمة المتطورة لدينا، ومع موظفينا المؤهلين الذين يلبنون متطلبات العصور ومع موادنا الخام عالية الجودة التي..... نستخدمها في منتجاتنا أفضل جودة وأفضل الأسعار. يمكنك تغيير مظهر منازلكم وأماكن عملكم سيكون كافيًا بالنسبة لك أن تأتي إلى ديكودور

للتواصل / Contact

☎ 009 665 539 366 86 ☎ 009 665 682 967 66

☎ 009 665 620 037 66

✉ sale1@decodoorwpc.com

✉ sales2@decodoorwpc.com

🌐 www.decodoorwpc.com

📷 /decodoorwpc

📍 P.O. Box12469 Jeddah 21473 Kingdom of Saudi Arabia

🏠 Industrial Area Phase 3 Road No: 37  
Jeddah / Kingdom of Saudi Arabia



The most common problem with room doors used indoors at home is that the doors wear out quickly on wet surfaces. Composite door (WPC) is the door model that eliminates this problem and is the best in technological terms. In recent years, composite doors have begun to be preferred more by architects, engineering companies and practitioners. The reason for this is that when it comes to composite, it is resistant to external weather conditions, and composite materials are used on exterior surfaces for both design purposes and durability.

Contrary to popular belief, the culture of washing has developed in cleaning living spaces such as homes and streets, especially in Middle Eastern countries. Cleaning in these areas is done from top to bottom. What is inevitable here is that the doors deform quickly due to the water and humidity they are exposed to. To prevent this, composite doors are among the most preferred doors. Nowadays, doors are changing very frequently and solid doors are preferred. Those looking for solid doors, designer doors and durable doors prefer DECODOOR doors.



### Composite Door Features

Composite doors are healthy. It prevents the formation of dirt and bacteria on its surface and is antibacterial. It is extremely resistant to moisture and moisture. It does not cause bending, bending, deforming or shedding due to water. It is in the B1 fireproof class. The composite door has all the visuals of wooden materials and is resistant to impacts. It can be produced in desired sizes and models with a wide range of size options. It is made by evaluating recycled waste in DECODOOR integrated production facilities. For this reason, it is environmentally friendly.

المشكلة الأكثر شيوعاً في أبواب الغرف المستخدمة داخل المنزل هي أن الأبواب تتآكل بسرعة على الأسطح الرطبة. الأبواب الكومبوزيت هي نموذج الباب الذي يزيل هذه المشكلة وهو الأفضل من الناحية التكنولوجية. في السنوات الأخيرة، أصبحت الأبواب الكومبوزيت أكثر تفضيلاً من قبل المهندسين المعماريين والشركات الهندسية والمقاولين. والسبب في ذلك هو أنه عندما يتعلق الأمر بالكومبوزيت فهو مقاوم للظروف الجوية الخارجية، ويتم استخدام المواد الكومبوزيت على الأسطح الخارجية لأغراض التصميم والمتانة.

وخلافاً للاعتقاد الشائع، تطورت ثقافة الغسيل في تنظيف أماكن المعيشة مثل المنازل والشوارع، وهي السائدة بشكل خاص في دول الشرق الأوسط. يتم التنظيف في هذه المناطق من الأعلى إلى الأسفل. ما لا مفر منه هنا هو أن الأبواب تنتشوه بسرعة بسبب الماء والرطوبة التي تتعرض لها. ولمنع ذلك، تعتبر الأبواب الكومبوزيت من بين الأبواب الأكثر تفضيلاً. في الوقت الحاضر، تتغير الأبواب بشكل متكرر ويفضل الأبواب الصلبة. أولئك الذين يبحثون عن أبواب صلبة وأبواب مصممة وأبواب متينة يفضلون أبواب ديكودور.

### مميزات الباب الكومبوزيت

الأبواب المركبة صحية. يمنع تكون الأوساخ والبكتيريا على سطحه وهو مضاد للجراثيم. إنه مقاوم للغاية للماء والرطوبة. لا يسبب الانحناء أو التشوه أو التساقط بسبب الماء. إنه في فئة مقاومة للحريق 1ب. يحتوي الباب الكومبوزيت على جميع العناصر المرئية للمواد الخشبية وهو مقاوم للصدمات. يمكن إنتاجه بالأحجام والنماذج المرغوبة مع مجموعة واسعة من خيارات الحجم. يتم تصنيعه من خلال تقييم المواد المعاد تدويرها في مرافق الإنتاج المتكاملة في ديكودور. ولهذا السبب فهي صديقة للبيئة.

DD 101

WPC  
Room Door





DD 201

WPC  
Room Door



DD 102

WPC  
Room Door



DD 202

WPC  
Room Door



DD 103

WPC  
Room Door





DD 203

WPC  
Room Door



**DD 104**

WPC  
Room Door



**DD 204**

WPC  
Room Door



**DD 105**

WPC  
Room Door





**DD 205**

WPC  
Room Door



**DD 106**

WPC  
Room Door



DD 206

WPC  
Room Door



DD 107

WPC  
Room Door





**DD 207**

WPC  
Room Door



**DD 108**

WPC  
Room Door



**DD 208**

WPC  
Room Door



**DD 109**

WPC  
Room Door





DD 209

WPC  
Room Door





# COMPOSITE DOORS





DD 501

WPC  
Room Door





DD 502

WPC  
Room Door



DD 501

WPC  
Room Door



DD 502

WPC  
Room Door





DD 501

WPC  
Room Door





DD 502

WPC  
Room Door



DD 501

WPC  
Room Door



**DD 502**

WPC  
Room Door



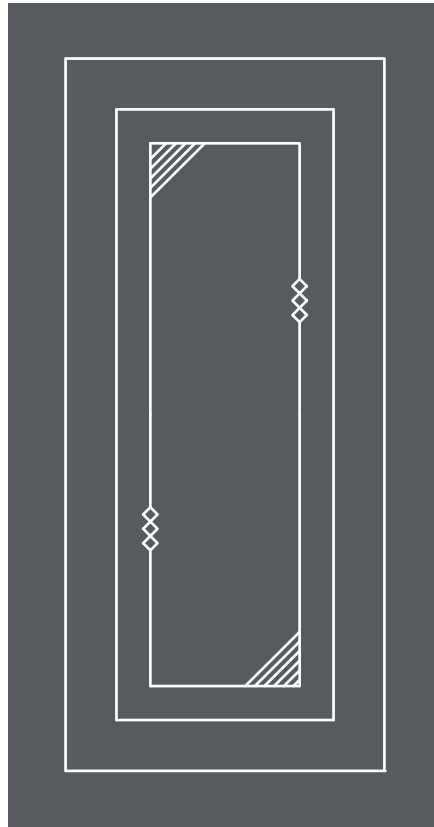
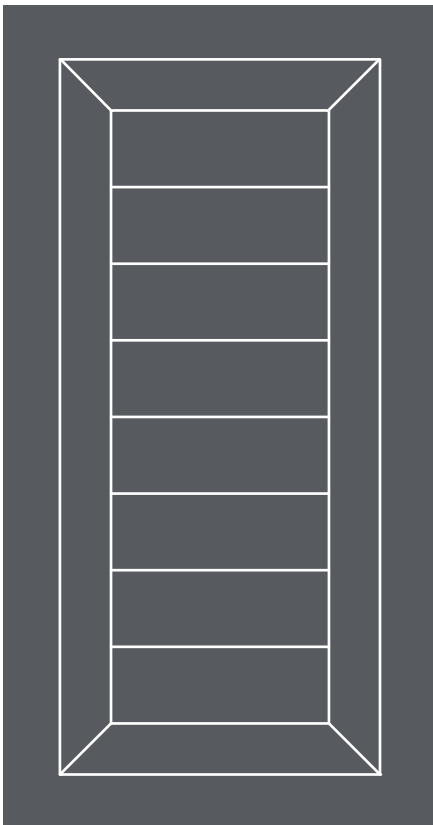
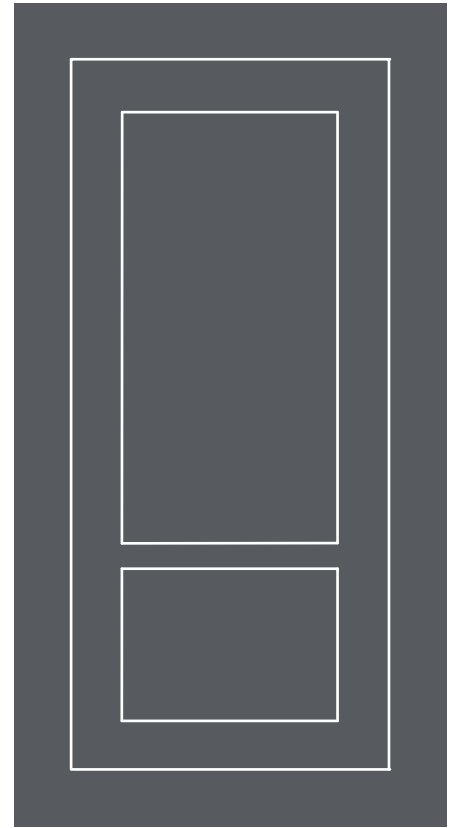
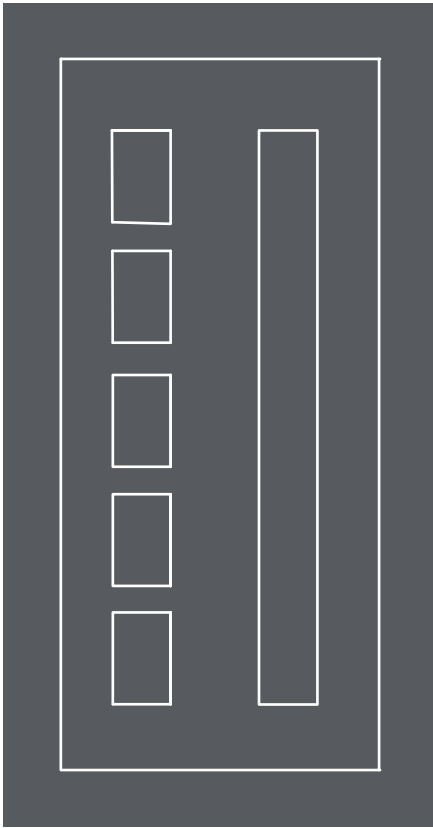



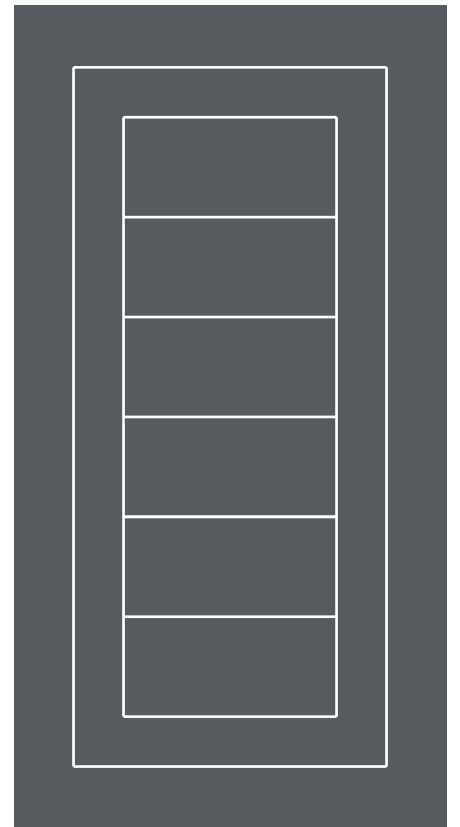
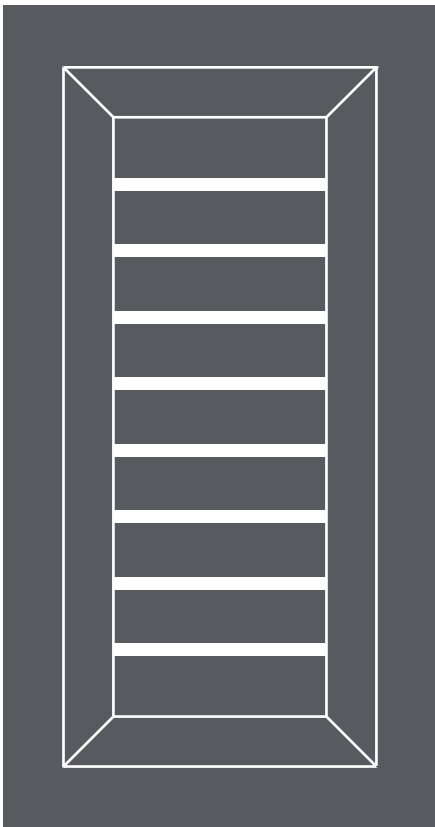
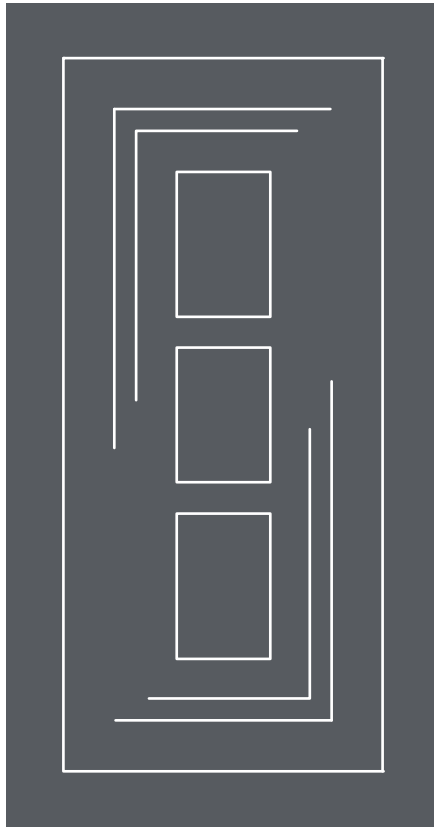
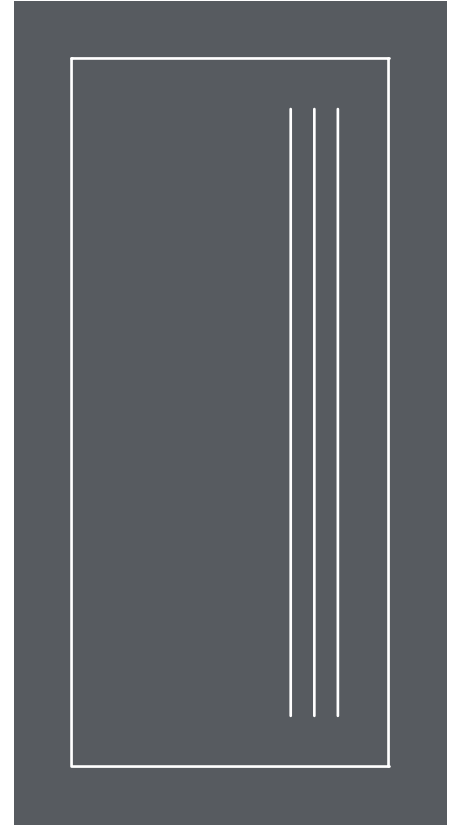
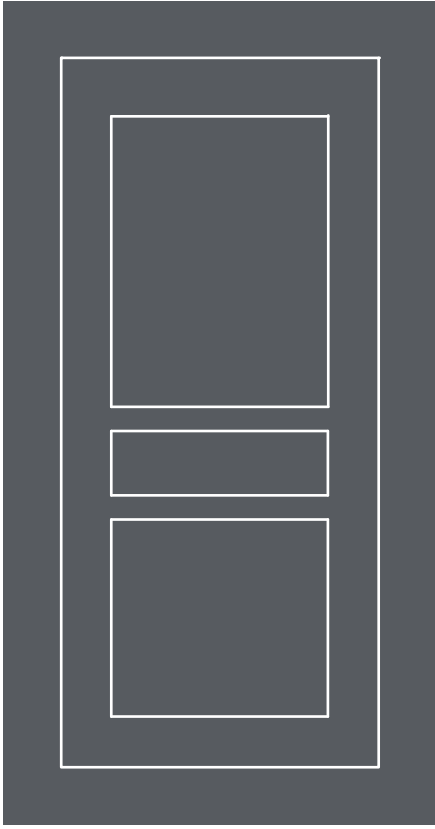

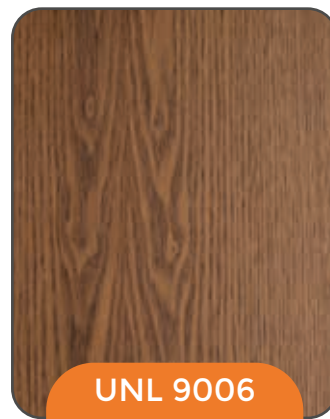
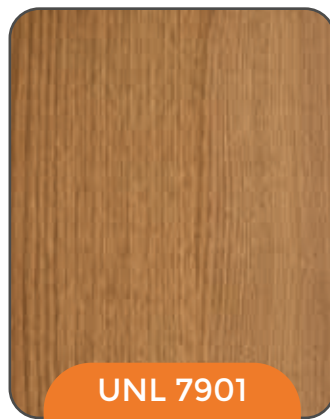
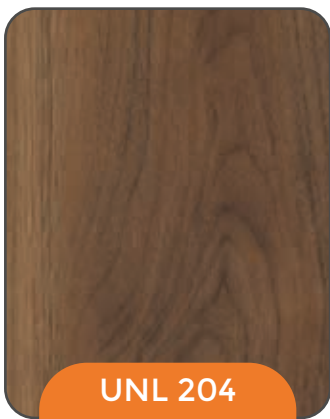
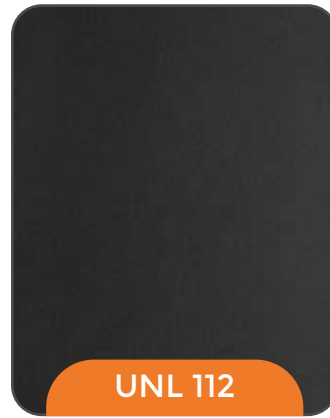
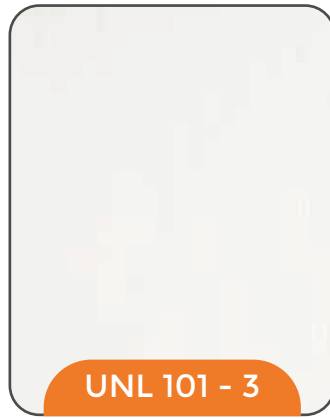
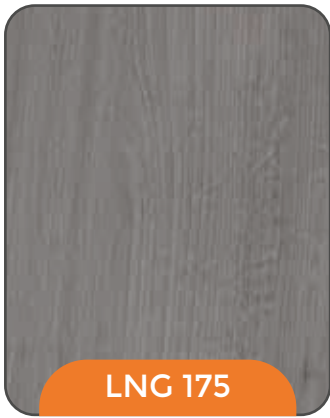
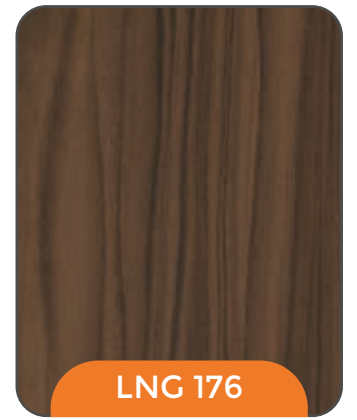
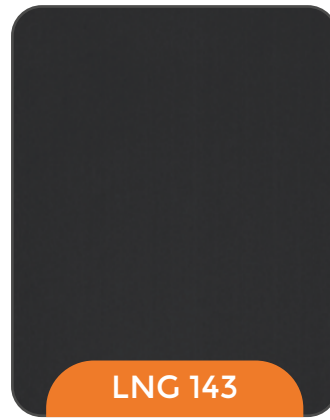
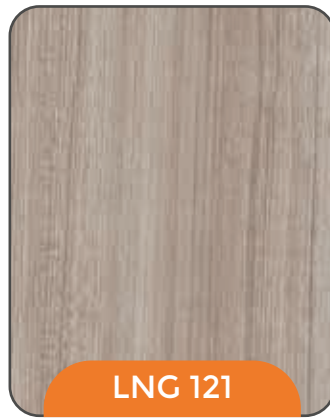
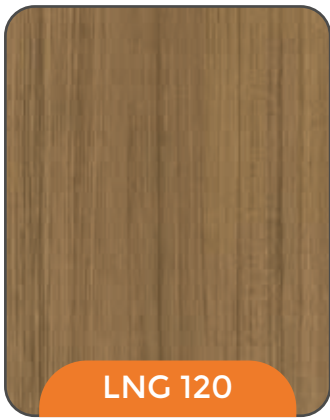
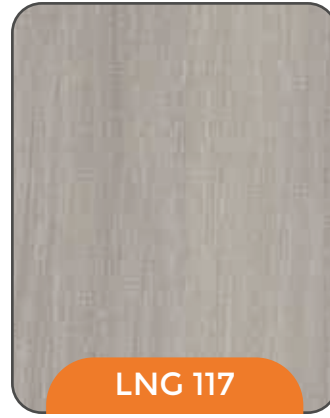
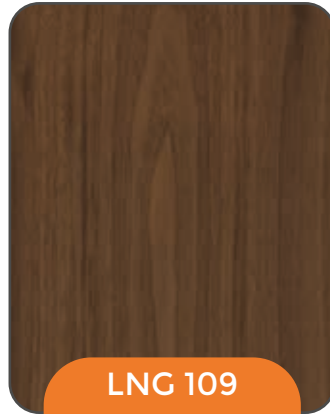
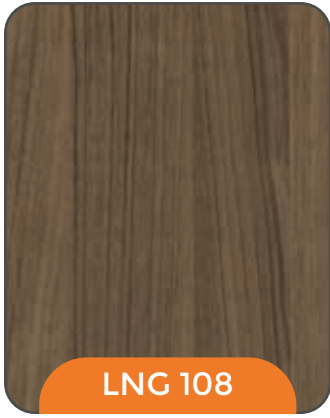

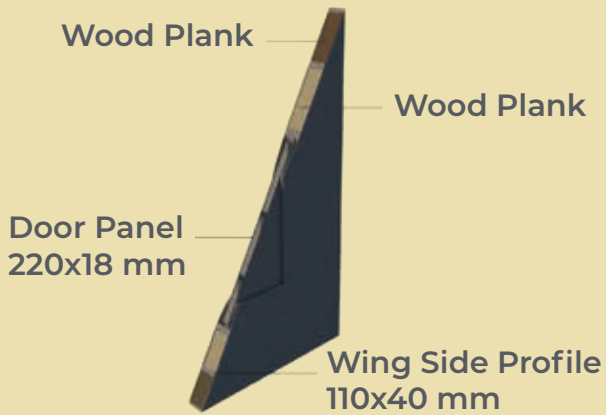

### DOOR ARTBOARD

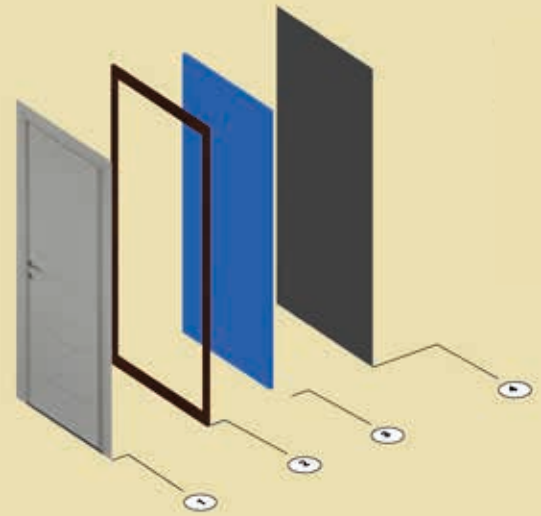

### FOAM DOORS DETAIL

- 1) WPC Sheet
- 2) Wooden Frame
- 3) Foam Board
- 4) WPC Sheet

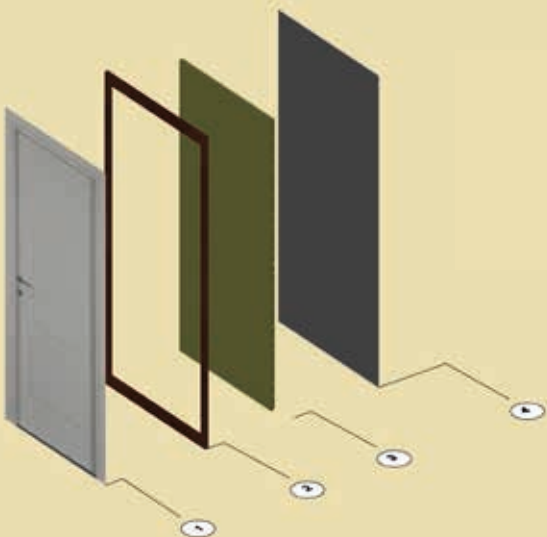

### FONTEX DOORS DETAIL

- 1) WPC Sheet
- 2) Fontex
- 3) Wooden Frame
- 4) WPC Sheet

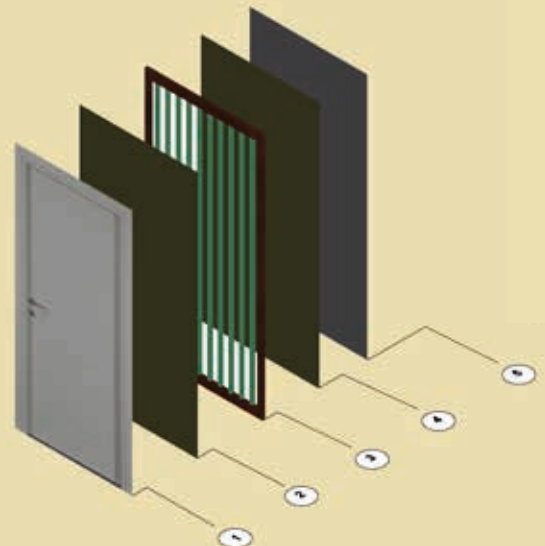

### WPC DOORS DETAIL

- 1) PVC Foil
- 2) Waterproof Composite Sheet
- 3) Wooden Frame and Strips
- 4) Waterproof Composite Sheet
- 5) PVC Foil

مقاسات حلق الباب / DOOR FRAME SIZES

10 cm FRAME

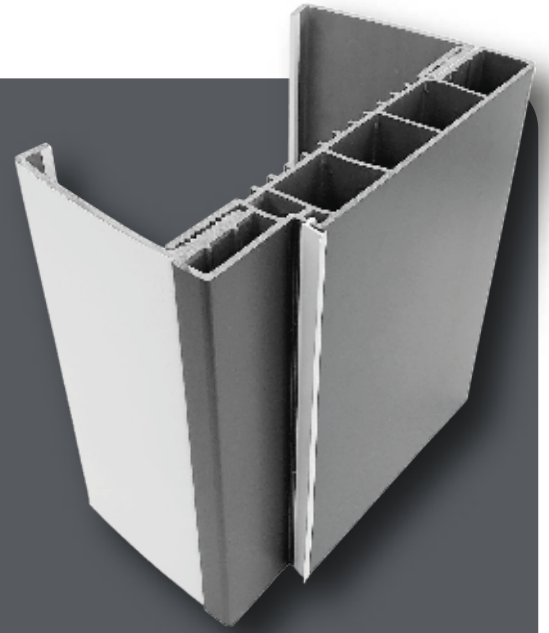
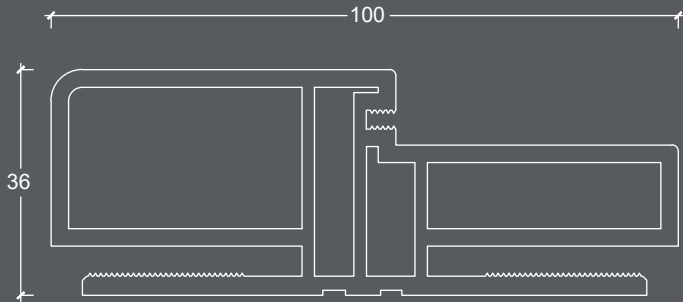

12 cm FRAME

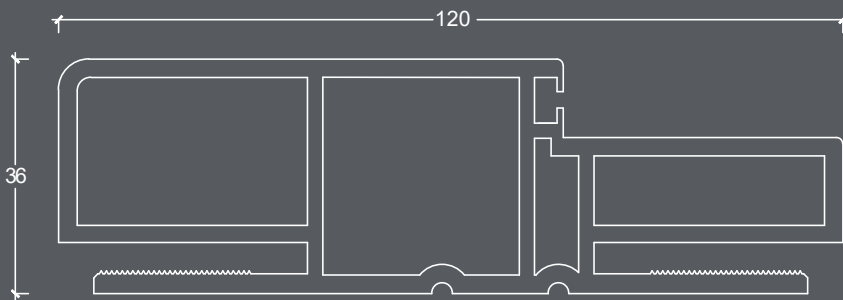

14 cm FRAME

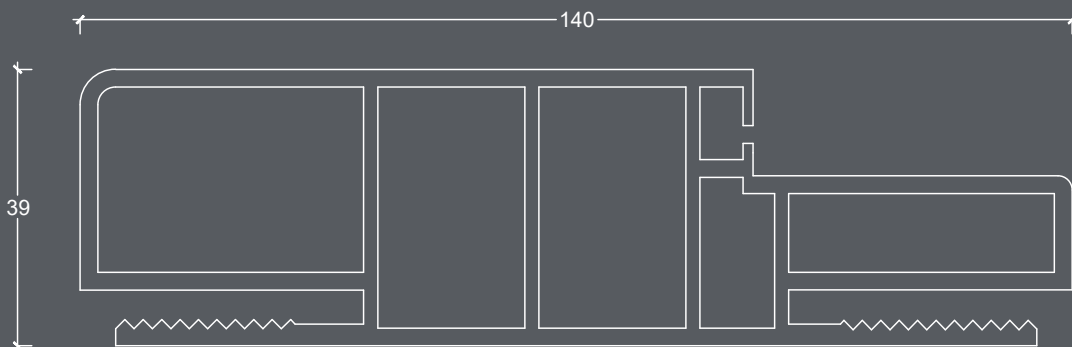



DOOR FRAME SIZES / مقاسات حلق الباب

16 cm FRAME

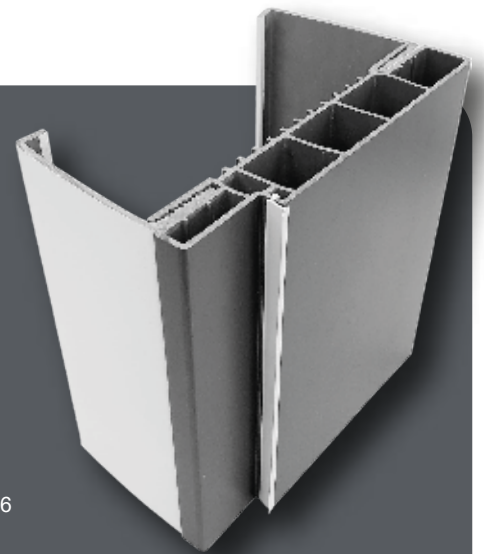
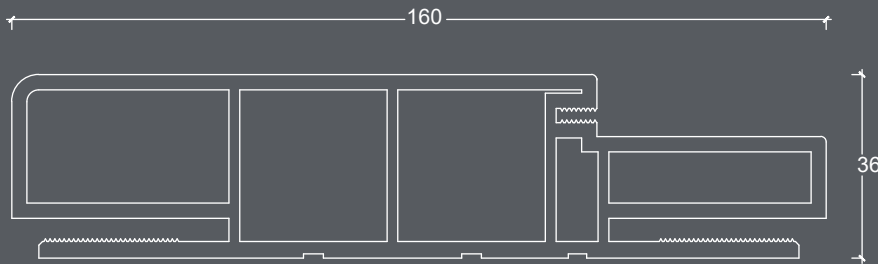

20 cm FRAME

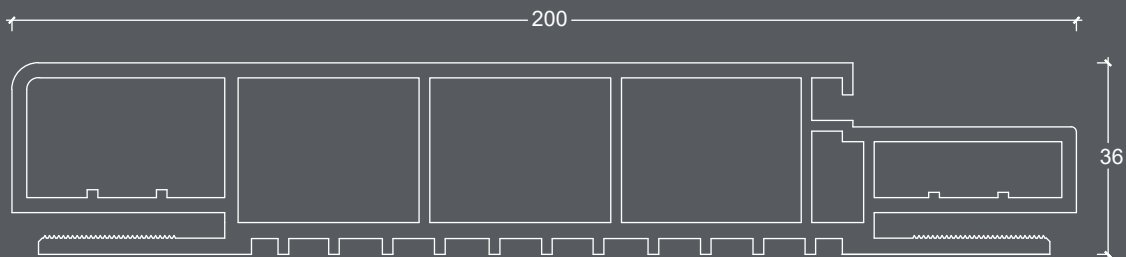

24 cm FRAME



**EXPANSION SIZES / مقاسات البراويز**

**STRAIGHT EXPANSION - 45/90**

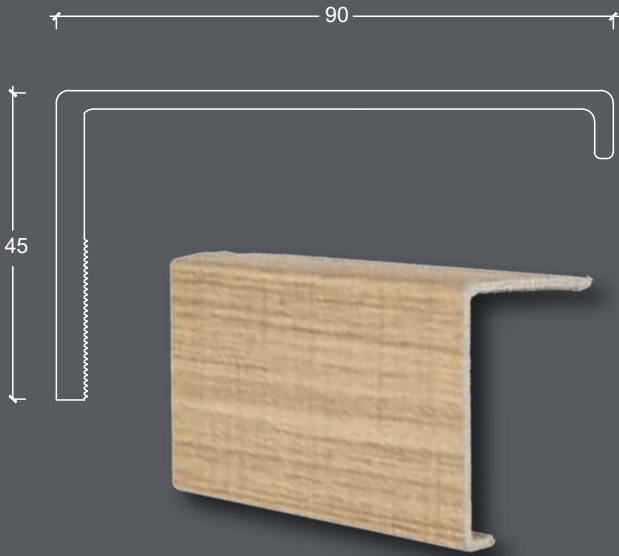

**EXTENSION EXPANSION - 75/90**

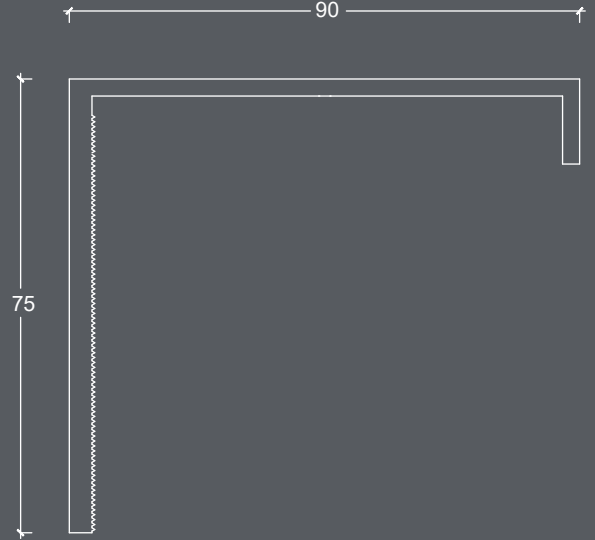

**DOOR EXTENSION PROFILE**

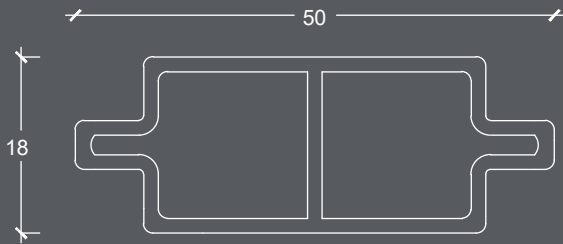

**WING SIDE PROFILE**



**DOOR INTERIOR PANEL**



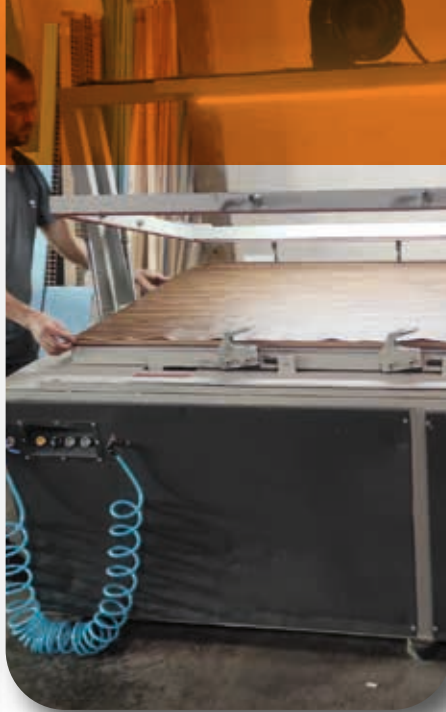

**DECODOOR**

 [www.decodoorwpc.com](http://www.decodoorwpc.com)





Contact / للتواصل

☎ 009 665 682 967 66 ☎ 009 665 539 366 86

☎ 009 665 620 037 66

✉ sale1@decodoorwpc.com

✉ sales2@decodoorwpc.com

🌐 www.decodoorwpc.com

📷 /decodoorwpc

📍 P.O. Box12469 Jeddah 21473 Kingdom of Saudi Arabia

🏭 Industrial Area Phase 3 Road No: 37  
Jeddah / Kingdom of Saudi Arabia